

Technical specification

- 1 **Ceiling** - upholstered, equipped with lighting and exhaust fans
- 2 **Upholstered wall** - full, 3" (75 mm) thick, upholstered on both sides, acoustic filling with sound isolation properties
- 3 **Columns** - 3" x 3" (75 x 75 mm), powder coated
- 4 **Shelf** - 4/8" / 12 mm MDF, colour: black, can be mounted only to upholstered walls with 39 3/8" / 1000mm width.
- 5 **Aluminum strips** - 2/8" (5 mm) thick
- 6 **Glass wall** - toughened glass, 2/8" (6 mm) thick
- 7 **Glass door** - toughened glass, 3/8" (8 mm) thick, equipped with hinges, handle with a lock and gaskets system improving the acoustic properties of the booth
- 8 **Floor** - melamine plate + acoustic covering (7/8" / 21mm thickness), colour: graphite - option with additional fee
- 9 **Fans:**
 - in - take (near the floor) - can be turned on and off, with adjustable fan speed. The exact location can be found on the shop drawings.
 - exhaust - integrated with the ceiling lamp

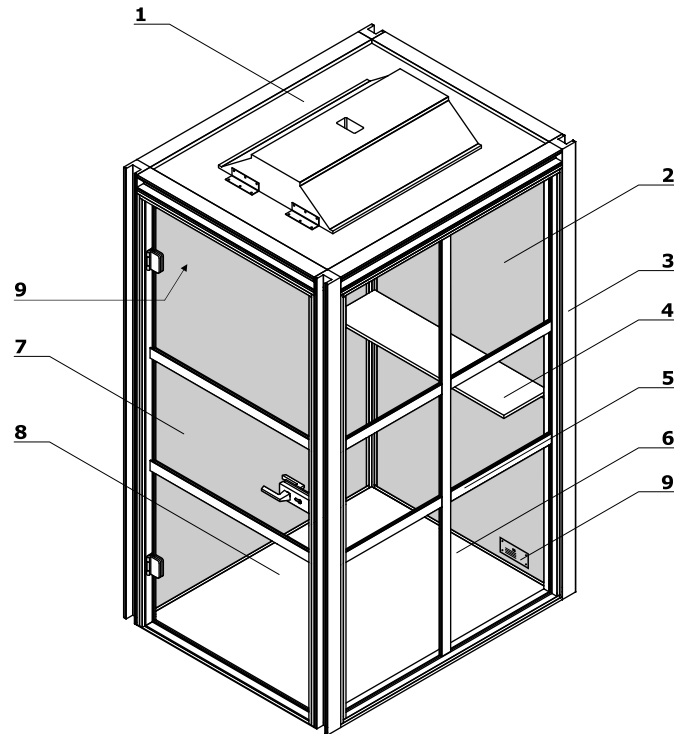

Attention! In standard the booth has no floor.

Configuration examples

HK01

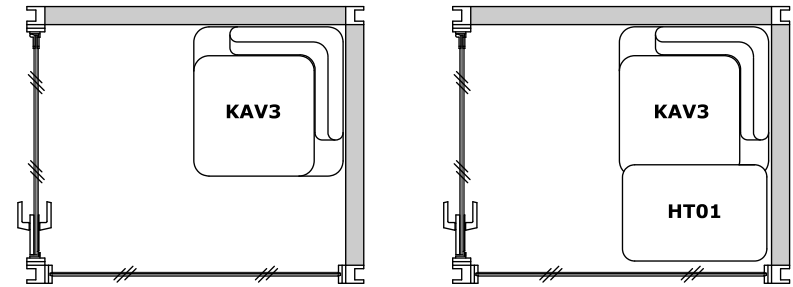

HK021

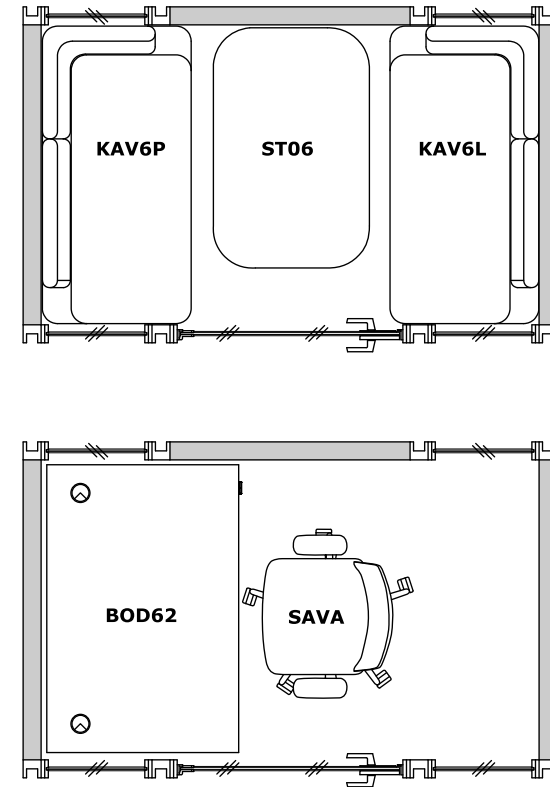

Configuration examples

HK03

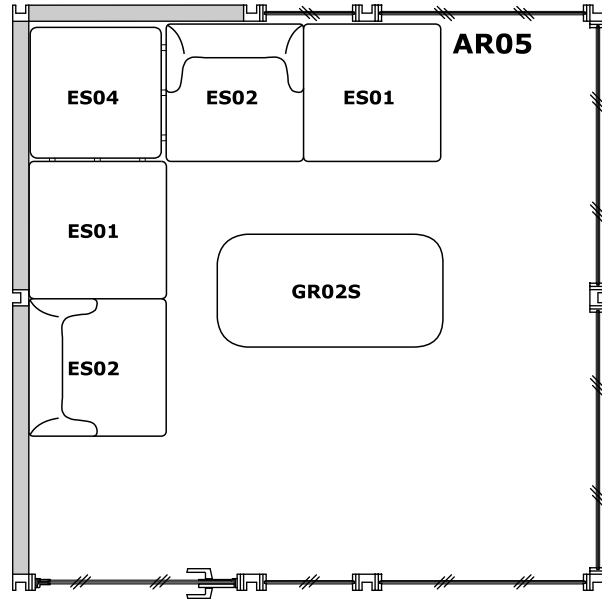
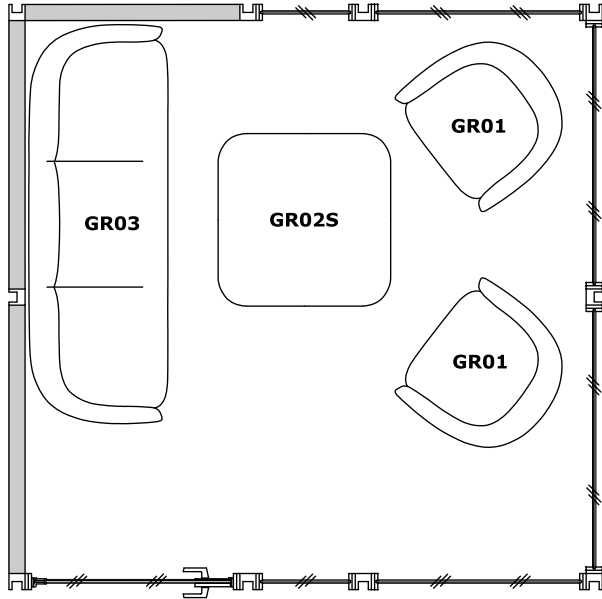
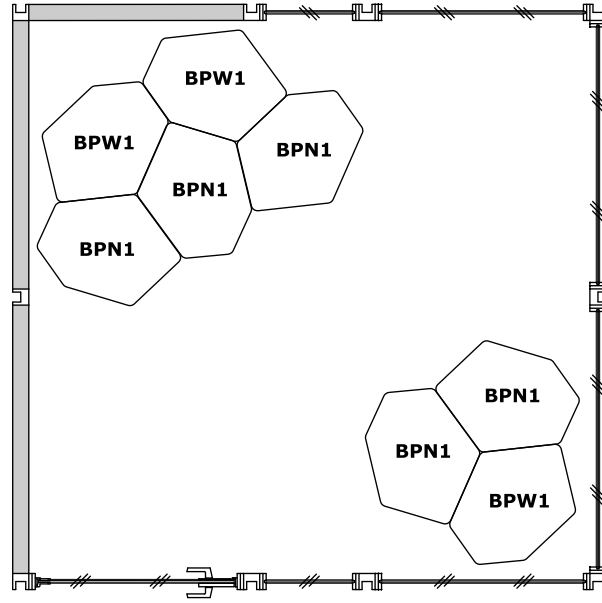
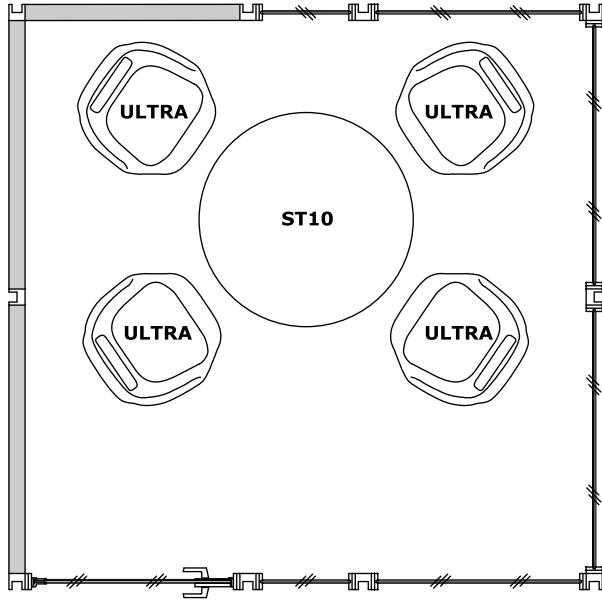







Dimensions (inch/mm)

Mediabox location

1 Mediabox - 2x110V + 1xUSB + 1xUSB type C

- A** - on the left wall near the floor
- B** - on the right wall near the floor
- C** - on the shorter wall above 740mm height

Legend:

-  in - take fans (near the floor) can be turned on and off, with adjustable fan speed. - Attention! It is suggested not to block fans to ensure the proper airflow rate
-  motion sensor (activates the exhaust fans and lighting)
-  wireless light switch - which can be situated in any place
-  left / right door option
-  sliding door
-  exhaust fans are integrated with the ceiling lamp

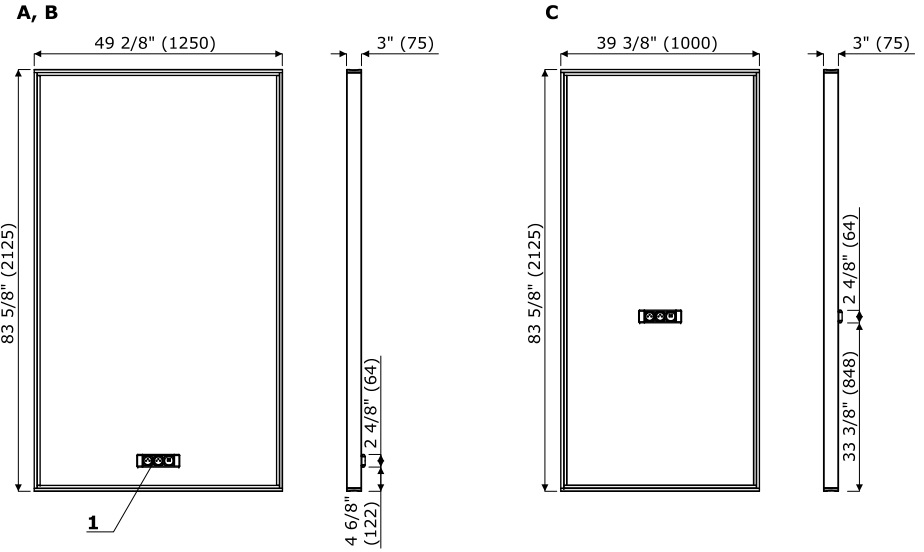

HK01

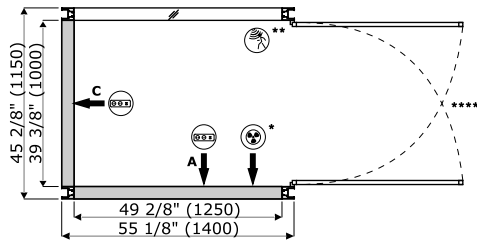

HK021

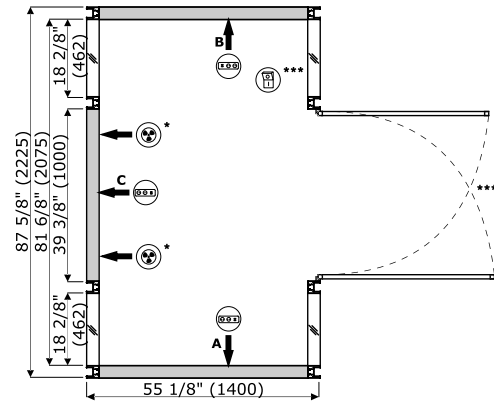

HK04

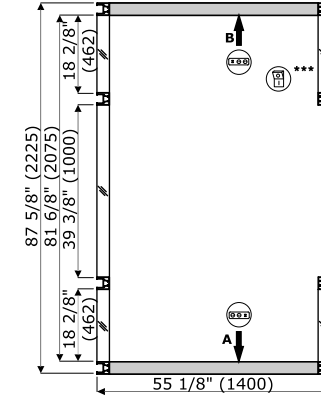

Dimensions (inch/mm)

HK03

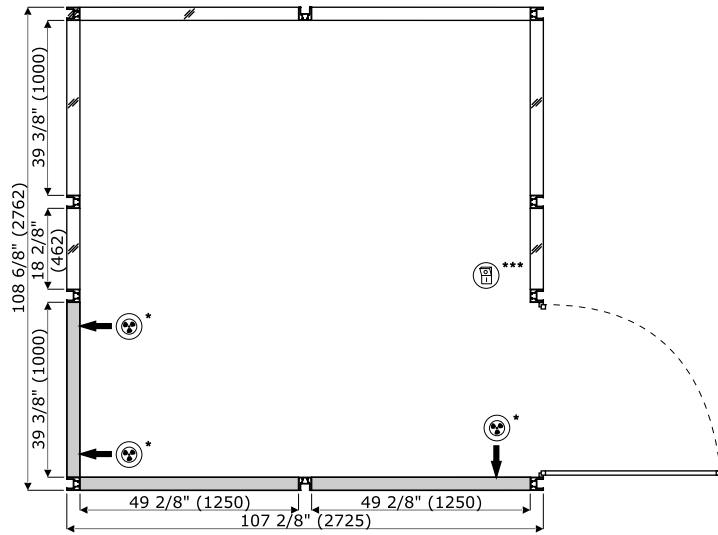



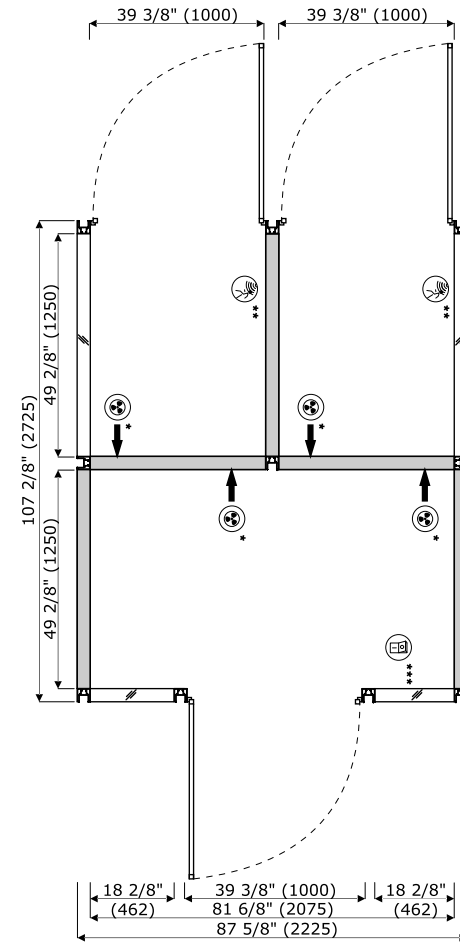

HK05



Dimensions (inch/mm)



Legend:

-  in - take fans (near the floor) can be turned on and off, with adjustable fan speed. - Attention! It is suggested not to block fans to ensure the proper airflow rate
-  motion sensor (activates the exhaust fans and lighting)
-  wireless light switch - which can be situated in any place
-  exhaust fans are integrated with the ceiling lamp

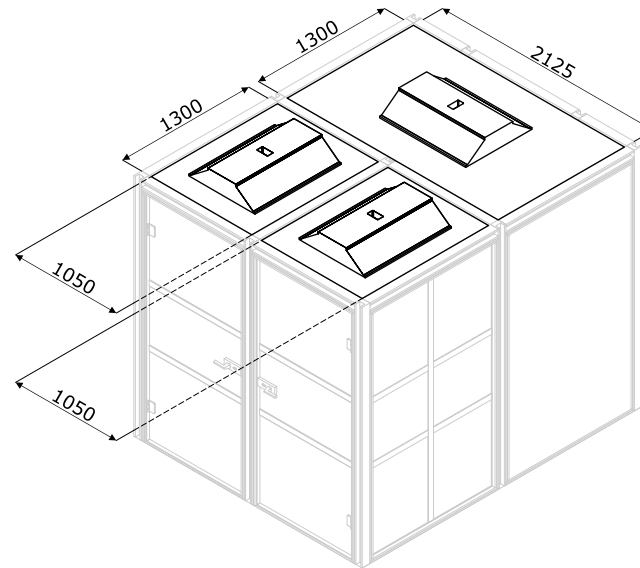
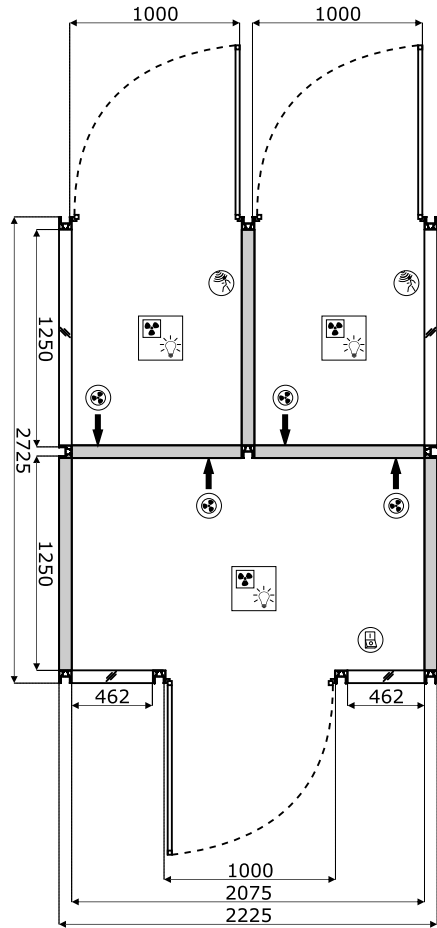
HK05



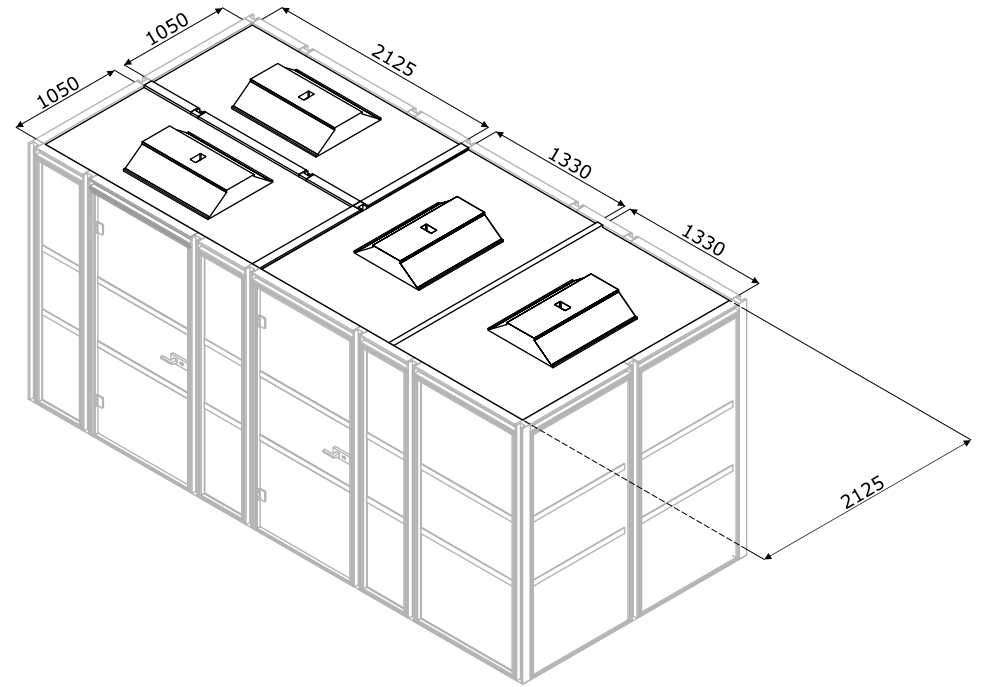
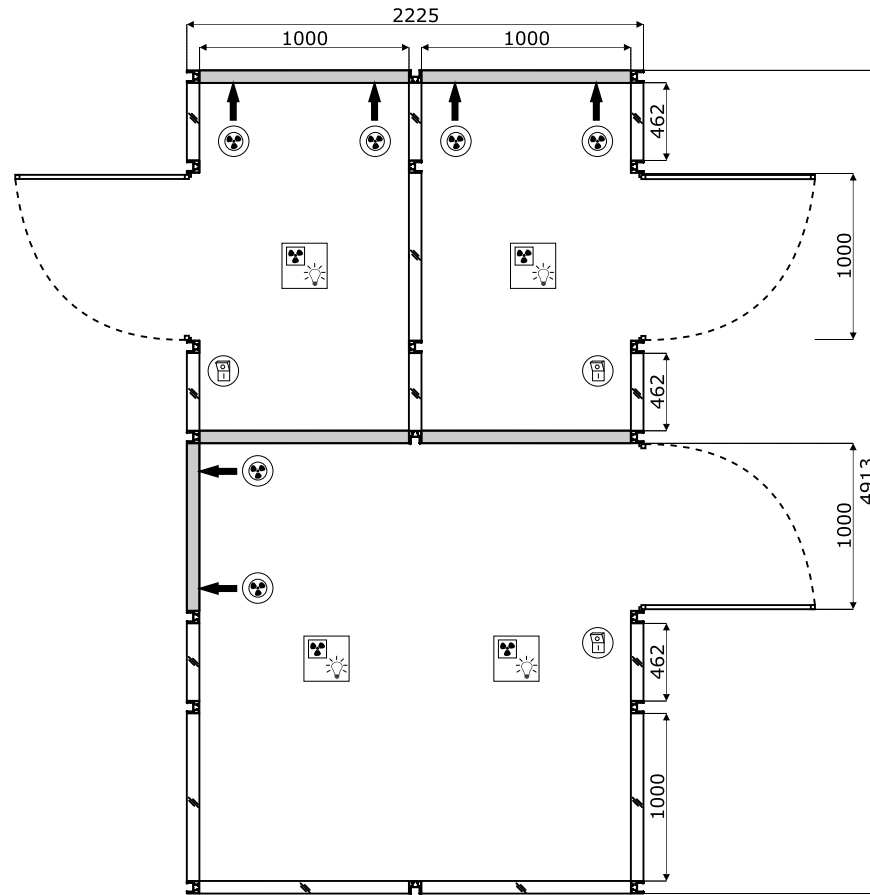

Dimensions (inch/mm)**Legend:**

-  in - take fans (near the floor) can be turned on and off, with adjustable fan speed. - Attention! It is suggested not to block fans to ensure the proper airflow rate
-  wireless light switch - which can be situated in any place
-  exhaust fans are integrated with the ceiling lamp

HK06

Dimensions (inch/mm)

Legend:

-  in - take fans (near the floor) can be turned on and off, with adjustable fan speed. - Attention! It is suggested not to block fans to ensure the proper airflow rate
 -  motion sensor (activates the exhaust fans and lighting)
 -  wireless light switch - which can be situated in any place
- exhaust fans are integrated with the ceiling lamp

HK07

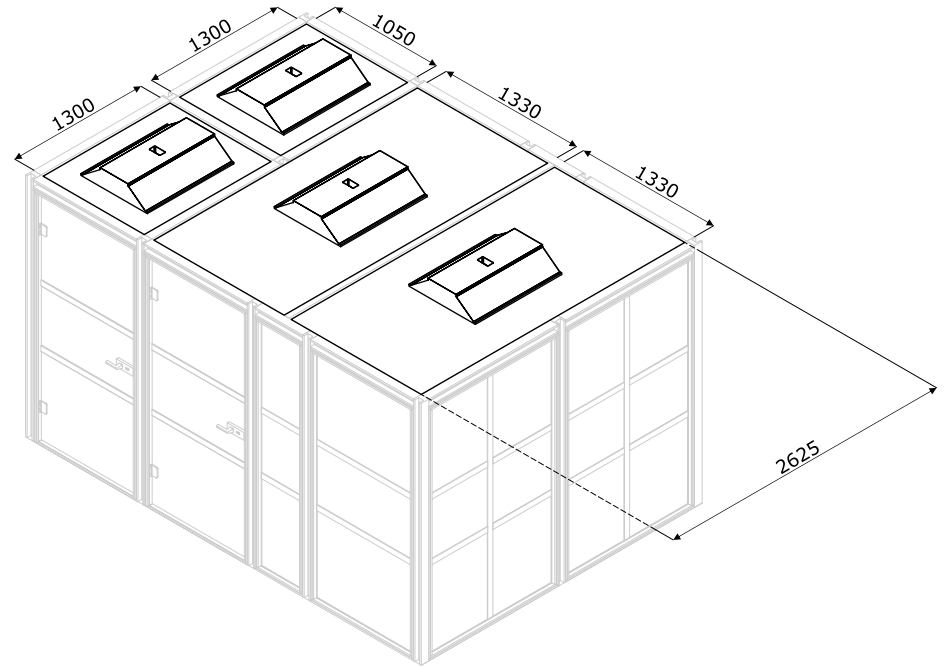
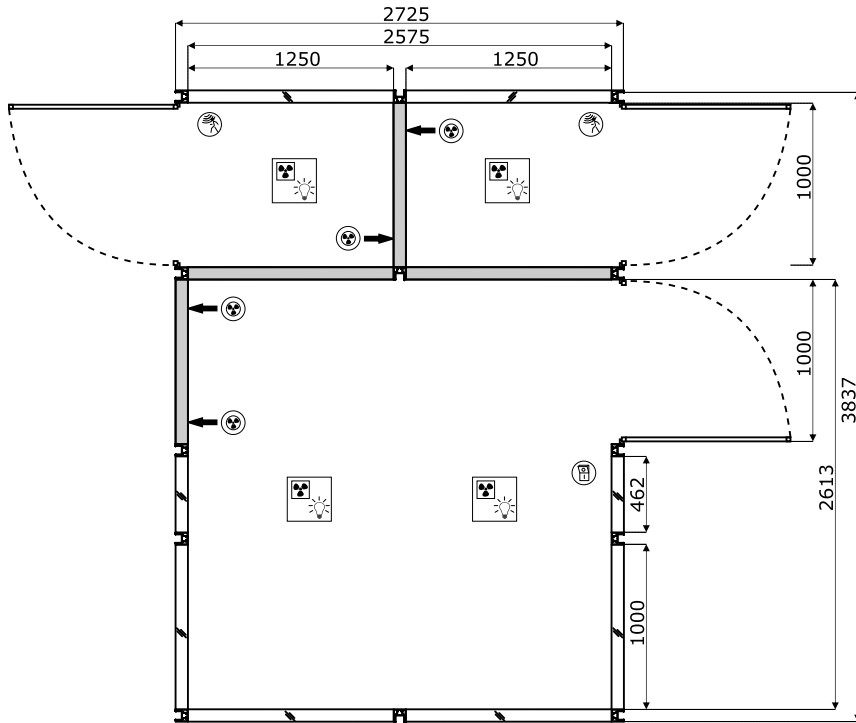

Table

- 1 Top** - MFC 18 mm, ABS edges 2 mm
- 2 Column** - powder coated steel, Ø 30mm
- 3 Base** - sheet metal, powder coated steel, 5 mm thick

